



8K x 8 Static RAM

Features

- 55, 70 ns access times
- CMOS for optimum speed/power
- Easy memory expansion with \overline{CE}_1 , CE_2 , and \overline{OE} features
- TTL-compatible inputs and outputs
- Automatic power-down when deselected

Functional Description

The CY6264 is a high-performance CMOS static RAM organized as 8192 words by 8 bits. Easy memory expansion is provided by an active LOW chip enable (\overline{CE}_1), an active HIGH chip enable (CE_2), and active LOW output enable (\overline{OE}) and three-state drivers. Both devices have an automatic power-down feature (\overline{CE}_1), reducing the power consumption by

over 70% when deselected. The CY6264 is packaged in a 450-mil (300-mil body) SOIC.

An active LOW write enable signal (\overline{WE}) controls the writing/reading operation of the memory. When \overline{CE}_1 and \overline{WE} inputs are both LOW and CE_2 is HIGH, data on the eight data input/output pins (I/O_0 through I/O_7) is written into the memory location addressed by the address present on the address pins (A_0 through A_{12}). Reading the device is accomplished by selecting the device and enabling the outputs, \overline{CE}_1 and \overline{OE} active LOW, CE_2 active HIGH, while \overline{WE} remains inactive or HIGH. Under these conditions, the contents of the location addressed by the information on address pins is present on the eight data input/output pins.

The input/output pins remain in a high-impedance state unless the chip is selected, outputs are enabled, and write enable (\overline{WE}) is HIGH. A die coat is used to insure alpha immunity.

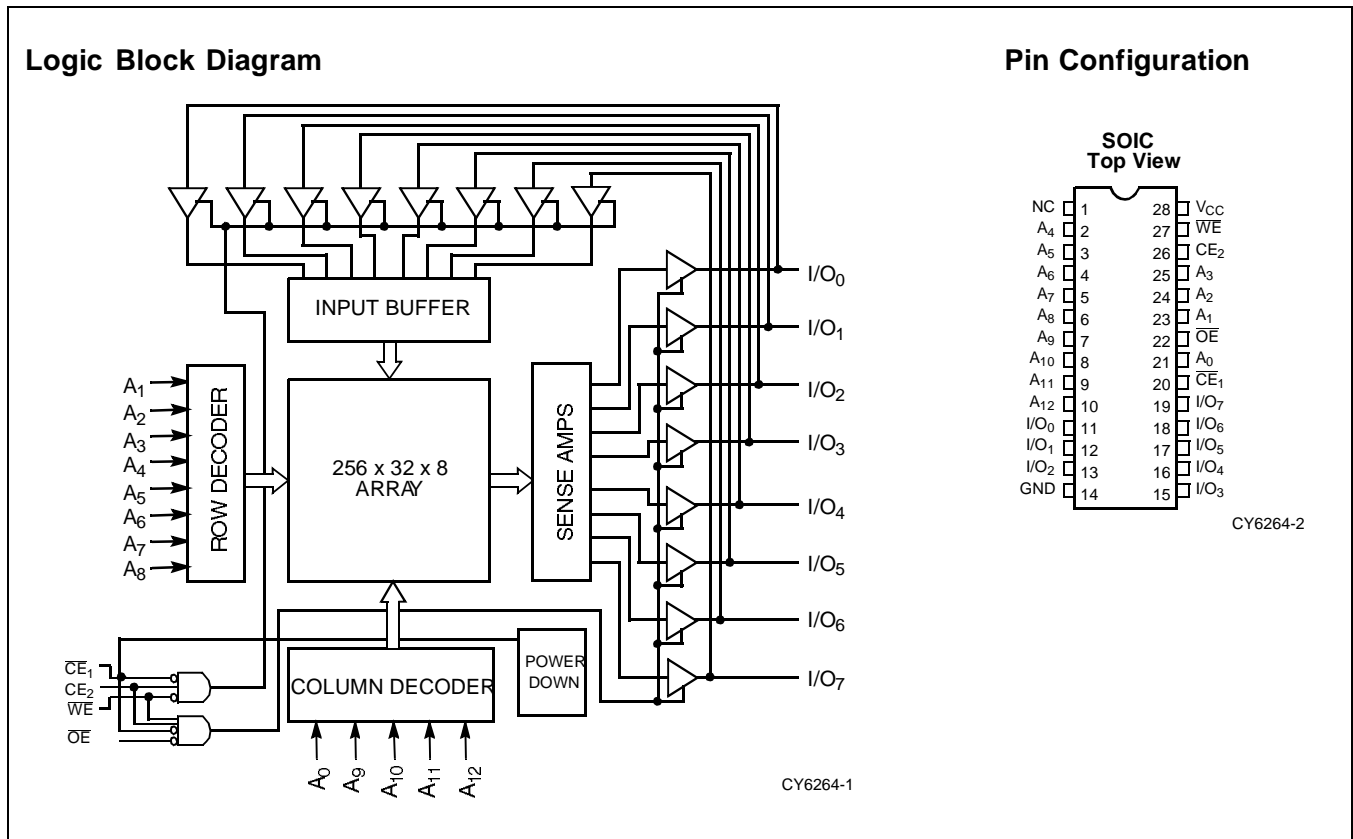

Selection Guide

	CY6264-55	CY6264-70
Maximum Access Time (ns)	55	70
Maximum Operating Current (mA)	100	100
Maximum Standby Current (mA)	20/15	20/15

Shaded area contains advanced information.

Maximum Ratings

(Above which the useful life may be impaired. For user guidelines, not tested.)

- Storage Temperature -65°C to +150°C
- Ambient Temperature with Power Applied..... -55°C to +125°C
- Supply Voltage to Ground Potential -0.5V to +7.0V
- DC Voltage Applied to Outputs in High Z State^[1] -0.5V to +7.0V
- DC Input Voltage^[1]..... -0.5V to +7.0V

- Output Current into Outputs (LOW)..... 20 mA
- Static Discharge Voltage >2001V (per MIL-STD-883, Method 3015)
- Latch-Up Current..... >200 mA

Operating Range

Range	Ambient Temperature	V _{CC}
Commercial	0°C to +70°C	5V ± 10%

Electrical Characteristics Over the Operating Range

Parameter	Description	Test Conditions	6264-55		6264-70		Unit
			Min.	Max.	Min.	Max.	
V _{OH}	Output HIGH Voltage	V _{CC} = Min., I _{OH} = -4.0 mA	2.4		2.4		V
V _{OL}	Output LOW Voltage	V _{CC} = Min., I _{OL} = 8.0 mA		0.4		0.4	V
V _{IH}	Input HIGH Voltage		2.2	V _{CC}	2.2	V _{CC}	V
V _{IL}	Input LOW Voltage ^[1]		-0.5	0.8	-0.5	0.8	V
I _{IX}	Input Load Current	GND ≤ V _I ≤ V _{CC}	-5	+5	-5	+5	μA
I _{OZ}	Output Leakage Current	GND ≤ V _I ≤ V _{CC} , Output Disabled	-5	+5	-5	+5	μA
I _{OS}	Output Short Circuit Current ^[2]	V _{CC} = Max., V _{OUT} = GND		-300		-300	mA
I _{CC}	V _{CC} Operating Supply Current	V _{CC} = Max., I _{OUT} = 0 mA		100		100	mA
I _{SB1}	Automatic \overline{CE}_1 Power-Down Current	Max. V _{CC} , $\overline{CE}_1 \geq V_{IH}$, Min. Duty Cycle=100%		20		20	mA
I _{SB2}	Automatic \overline{CE}_1 Power-Down Current	Max. V _{CC} , $\overline{CE}_1 \geq V_{CC} - 0.3V$, V _{IN} ≥ V _{CC} - 0.3V or V _{IN} ≤ 0.3V		15		15	mA

Shaded area contains advanced information.

Capacitance^[3]

Parameter	Description	Test Conditions	Max.	Unit
C _{IN}	Input Capacitance	T _A = 25°C, f = 1 MHz, V _{CC} = 5.0V	7	pF
C _{OUT}	Output Capacitance		7	pF

Notes:

1. Minimum voltage is equal to -3.0V for pulse durations less than 30 ns.
2. Not more than 1 output should be shorted at one time. Duration of the short circuit should not exceed 30 seconds.
3. Tested initially and after any design or process changes that may affect these parameters.

AC Test Loads and Waveforms

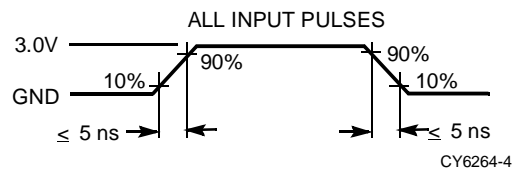
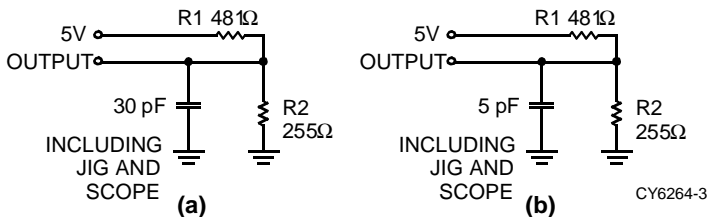

Equivalent to: THÉVENIN EQUIVALENT

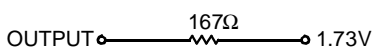

Switching Characteristics Over the Operating Range^[4]

Parameter	Description	6264-55		6264-70		Unit
		Min.	Max.	Min.	Max.	
READ CYCLE						
t _{RC}	Read Cycle Time	55		70		ns
t _{AA}	Address to Data Valid		55		70	ns
t _{OHA}	Data Hold from Address Change	5		5		ns
t _{ACE1}	\overline{CE}_1 LOW to Data Valid		55		70	ns
t _{ACE2}	CE ₂ HIGH to Data Valid		40		70	ns
t _{DOE}	\overline{OE} LOW to Data Valid		25		35	ns
t _{LZOE}	\overline{OE} LOW to Low Z	3		5		ns
t _{HZOE}	\overline{OE} HIGH to High Z ^[5]		20		30	ns
t _{LZCE1}	\overline{CE}_1 LOW to Low Z ^[6]	5		5		ns
t _{LZCE2}	CE ₂ HIGH to Low Z	3		5		ns
t _{HZCE}	\overline{CE}_1 HIGH to High Z ^[5, 6] CE ₂ LOW to High Z		20		30	ns
t _{PU}	\overline{CE}_1 LOW to Power-Up	0		0		ns
t _{PD}	\overline{CE}_1 HIGH to Power-Down		25		30	ns
WRITE CYCLE^[7]						
t _{WC}	Write Cycle Time	50		70		ns
t _{SCE1}	\overline{CE}_1 LOW to Write End	40		60		ns
t _{SCE2}	CE ₂ HIGH to Write End	30		50		ns
t _{AW}	Address Set-Up to Write End	40		55		ns
t _{HA}	Address Hold from Write End	0		0		ns
t _{SA}	Address Set-Up to Write Start	0		0		ns
t _{PWE}	\overline{WE} Pulse Width	25		40		ns
t _{SD}	Data Set-Up to Write End	25		35		ns
t _{HD}	Data Hold from Write End	0		0		ns
t _{HZWE}	\overline{WE} LOW to High Z ^[5]		20		30	ns
t _{LZWE}	\overline{WE} HIGH to Low Z	5		5		ns

Shaded area contains advanced information.

Notes:

4. Test conditions assume signal transition time of 5 ns or less, timing reference levels of 1.5V, input pulse levels of 0 to 3.0V, and output loading of the specified I_{OL}/I_{OH} and 30-pF load capacitance.
5. t_{HZOE}, t_{HZCE}, and t_{HZWE} are specified with C_L = 5 pF as in part (b) of AC Test Loads. Transition is measured ±500 mV from steady-state voltage.
6. At any given temperature and voltage condition, t_{HZCE} is less than t_{LZCE} for any given device.
7. The internal write time of the memory is defined by the overlap of \overline{CE}_1 LOW, CE₂ HIGH, and \overline{WE} LOW. Both signals must be LOW to initiate a write and either signal can terminate a write by going HIGH. The data input set-up and hold timing should be referenced to the rising edge of the signal that terminates the write.

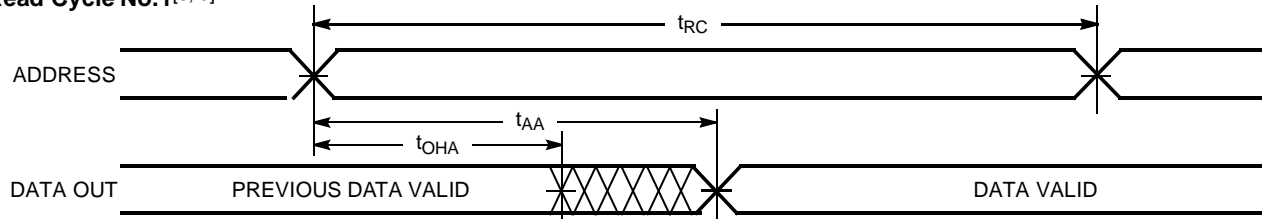
Switching Waveforms
Read Cycle No.1^[8, 9]

CY6264-5

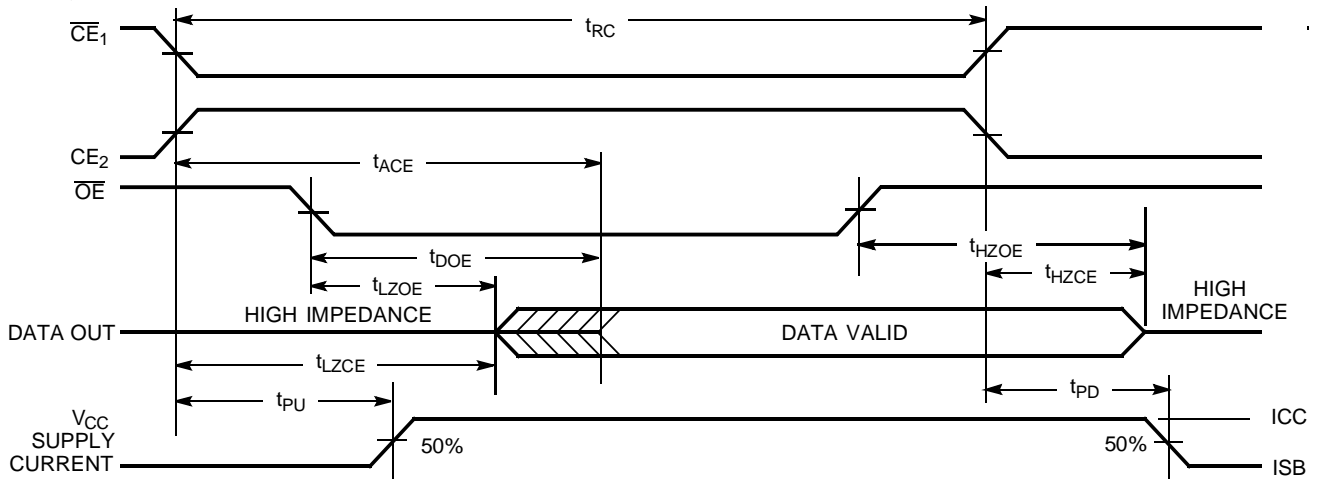
Read Cycle No. 2^[10, 11]

CY6264-6

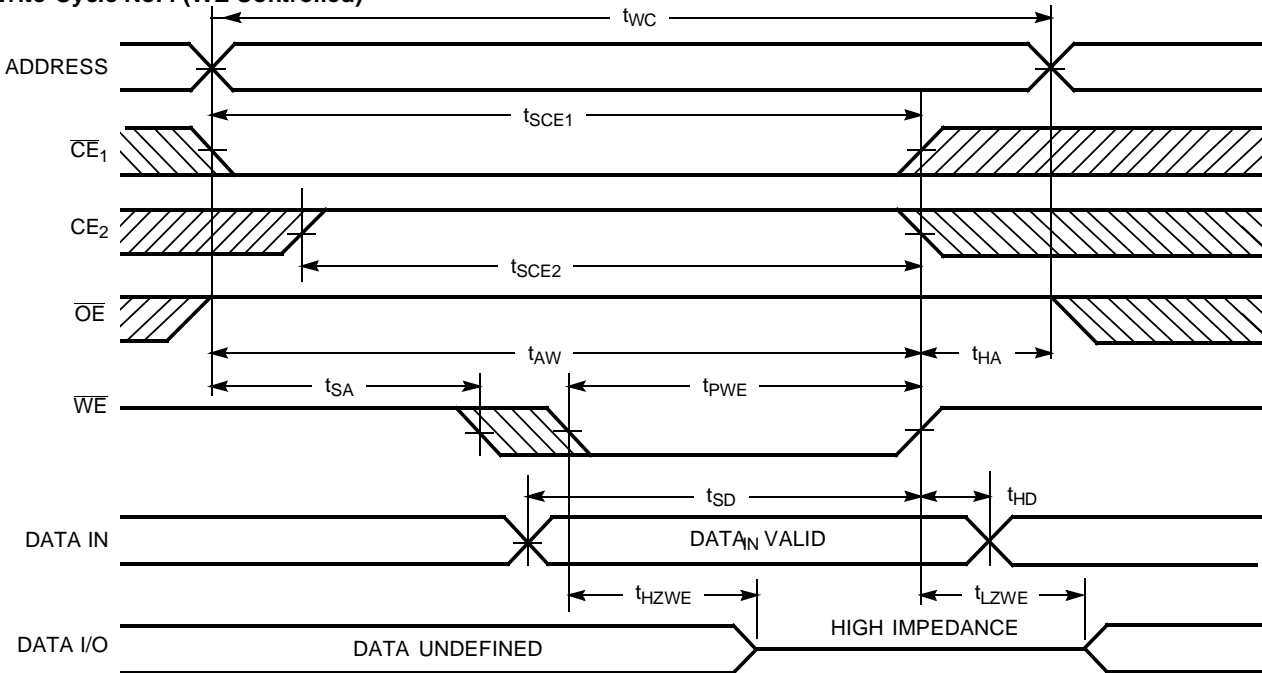
Write Cycle No. 1 (WE Controlled)^[9, 11]

CY6264-7

Notes:

8. Device is continuously selected. \overline{OE} , $\overline{CE} = V_{IL}$. $CE_2 = V_{IH}$.
9. Address valid prior to or coincident with \overline{CE} transition LOW.
10. \overline{WE} is HIGH for read cycle.
11. Data I/O is High Z if $\overline{OE} = V_{IH}$, $\overline{CE}_1 = V_{IH}$, or $\overline{WE} = V_{IL}$.

Switching Waveforms (continued)

Write Cycle No. 2 (\overline{CE} Controlled)^[9, 11, 12]

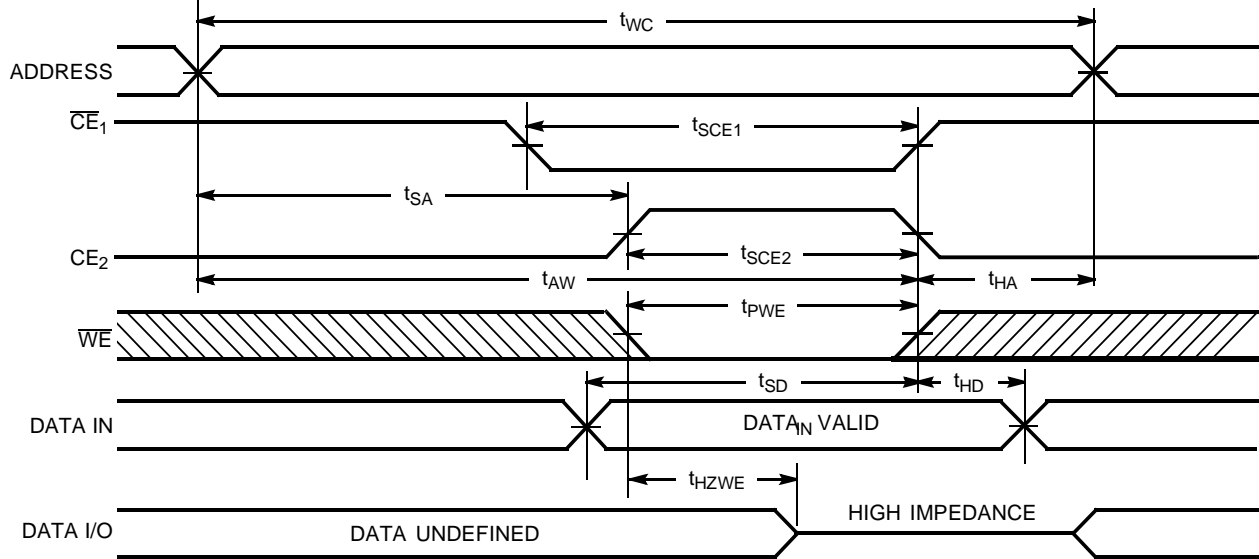

CY6264-8

Note:

12. If \overline{CE} goes HIGH simultaneously with \overline{WE} HIGH, the output remains in a high-impedance state.

Typical DC and AC Characteristics

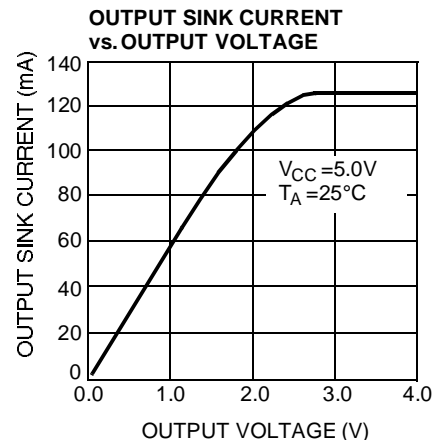
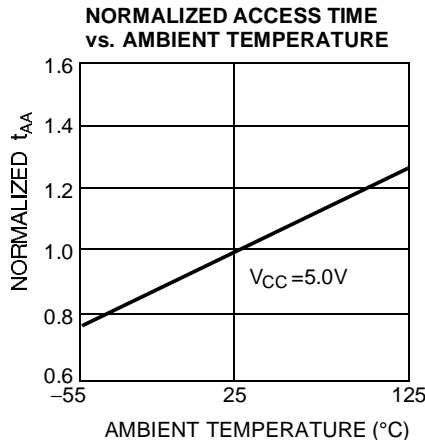
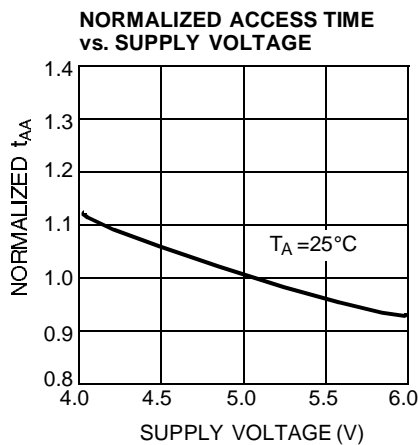
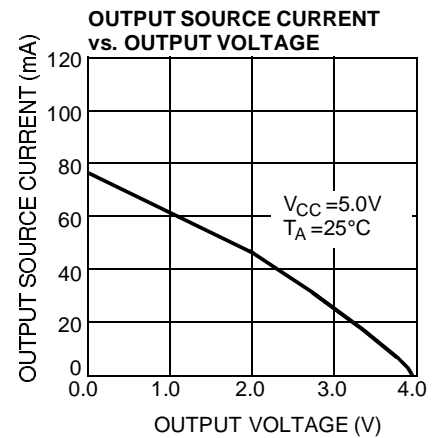
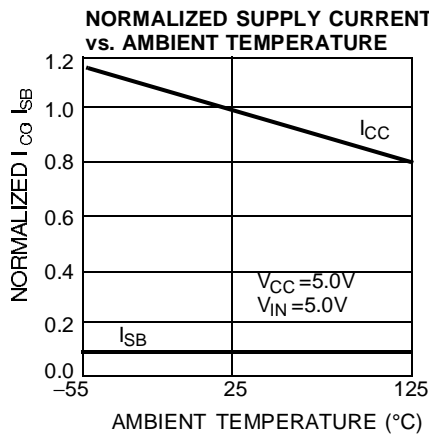
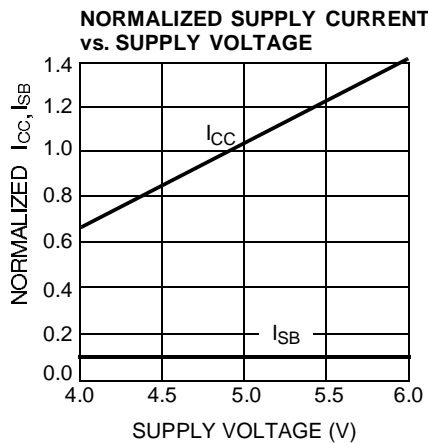

Typical DC and AC Characteristics (continued)

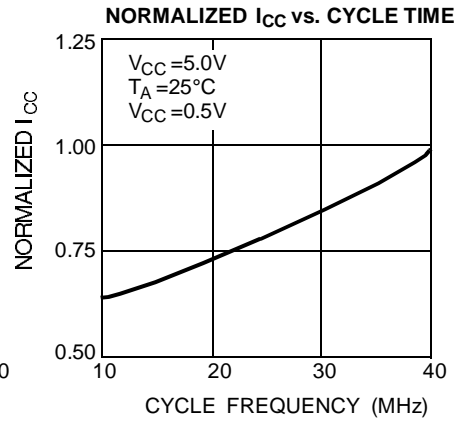
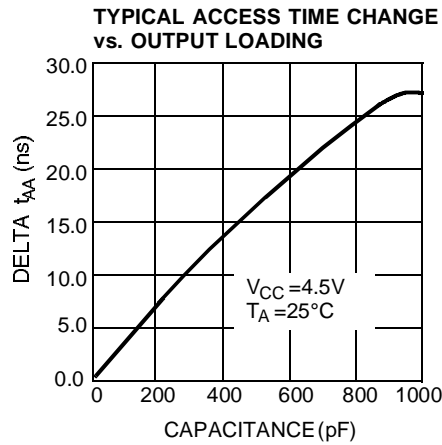
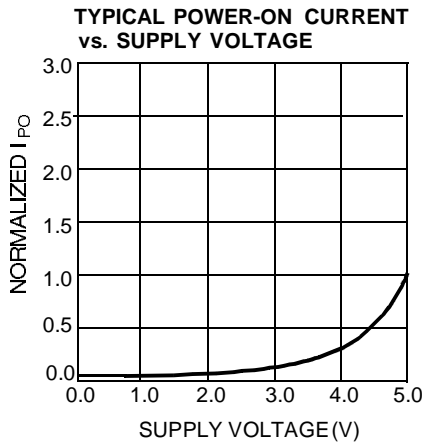

Truth Table

\overline{CE}_1	CE_2	\overline{WE}	\overline{OE}	Input/Output	Mode
H	X	X	X	High Z	Deselect/Power-Down
X	L	X	X	High Z	Deselect
L	H	H	L	Data Out	Read
L	H	L	X	Data In	Write
L	H	H	H	High Z	Deselect

Address Designators

Address Name	Address Function	Pin Number
A4	X3	2
A5	X4	3
A6	X5	4
A7	X6	5
A8	X7	6
A9	Y1	7
A10	Y4	8
A11	Y3	9
A12	Y0	10
A0	Y2	21
A1	X0	23
A2	X1	24
A3	X2	25

Ordering Information

Speed (ns)	Ordering Code	Package Name	Package Type	Operating Range
55	CY6264-55SC	S23	28-Lead 330-Mil SOIC ^[13]	Commercial
70	CY6264-70SC	S23	28-Lead 330-Mil SOIC ^[13]	Commercial
55	CY6264-55SNC	S22	28-Lead 300-Mil SOIC	Commercial
70	CY6264-70SNC	S22	28-Lead 300-Mil SOIC	Commercial

Shaded area contains advanced information.

Note:

13. Not recommended for new designs.

Document #: 38-00425-A

Package Diagrams

28-Lead 450-Mil (300-Mil Body Width) SOIC S22

.XXX = HYUNDAI DIMENSIONS
.XXX

(.XXX) = ANAM DIMENSIONS
(.XXX)

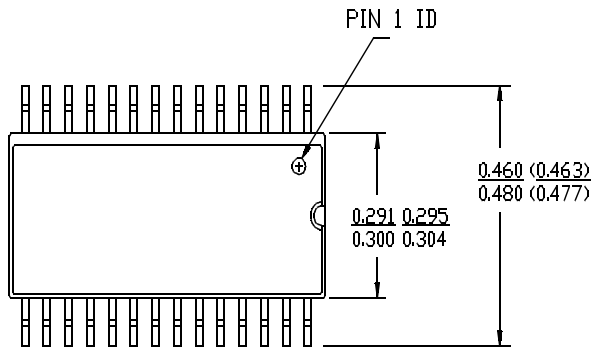

DIMENSIONS IN INCHES MIN.
MAX.
LEAD COPLANARITY 0.004 MAX.

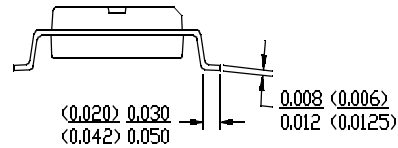
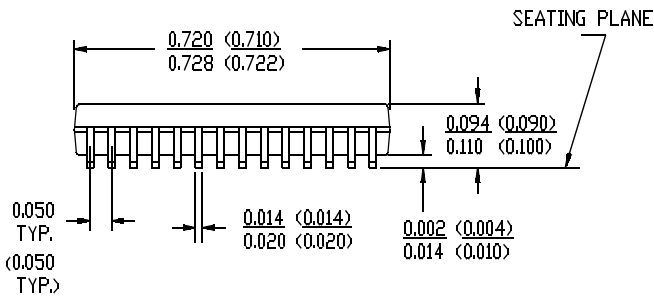

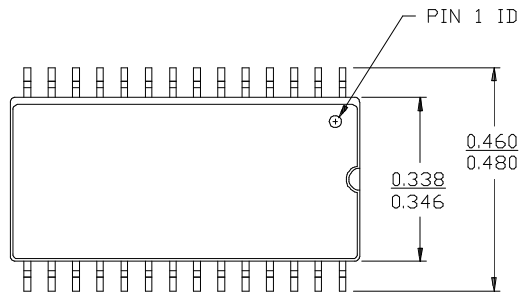
Package Diagrams (continued)
28-Lead (330-Mil) SOIC S23

DIMENSIONS IN INCHES MIN.
MAX.
 LEAD COPLANARITY 0.004 MAX.

